



**Department of Civil, Structural, and Environmental Engineering**

**SEESL Structural Engineering and Earthquake Simulation Laboratory SEESL**

212 Ketter Hall, North Campus, Buffalo, NY 14260-4300

Fax: (716) 645-3733 Tel: (716) 645 5400 X 16

<http://www.nees.buffalo.edu>

**Calibration Certificate**

Certificate Number: **UB-2004-06-20-04**

Instrument Description: **LC5** Three-Channel Load Cell Location: **SEESL**

**Test Equipment**

**Instrument Identification:**

Type of Instrument:	Instrument Name:	Serial Number:	Instrument Range:
Ax Force Transducer	LC5 CH-Ax	5	± 30 kip
Sx Force Transducer	LC5CH-Sx	5	± 5 kip
Mx Force Transducer	LC5 CH-Mx	5	± 30 kip-in
N1 Force Transducer	LC7CH-Ax	7	± 30 kip
N2 Force Transducer	LC9 CH-Ax	9	± 30 kip

**Conditioner Identification:**

Model Number	Serial Number:	Gain:	Excitation:
Ax 6032	0:9:1	500	10 V
Sx 6032	0:5:2	500	10 V
Mx 6032	0:5:3	500	10 V
N1 6032	0:8:1	500	10 V
N2 6032	0:7:2	500	10 V

**Readout Device Identification:**

Model Number	Serial Number:	Channel:
Ax 6000 DAS	1445183	74
Sx 6000 DAS	1445183	43
Mx 6000 DAS	1445183	44
N1 6000 DAS	1445183	66
N2 6000 DAS	1445183	59

**Calibration Factors:**

Full Scale Output:	Unamplified Full Scale Output	Amplified Output per Eng. Unit:
Ax ± 10 V	8.8 mV/Full Scale	± 0.1471 mV/kip
Sx ± 10 V	-4.8 mV/Full Scale	± -0.4762 mV/kip
Mx ± 10 V	-10.4 mV/Full Scale	± -0.1739 mV/kip-in
N1 ± 10 V	-8.5 mV/Full Scale	± -0.1412 mV/kip
N2 ± 10 V	-8.8 mV/Full Scale	± -0.1460 mV/kip



**Department of Civil, Structural, and Environmental Engineering**

**SEESL Structural Engineering and Earthquake Simulation Laboratory SEESL**

212 Ketter Hall, North Campus, Buffalo, NY 14260-4300

Fax: (716) 645-3733 Tel: (716) 645 5400 X 16

<http://www.nees.buffalo.edu>

Reference Equipment

Reference Instrument Identification:

1. <u>Type of Instrument:</u>	<u>Instrument Name:</u>	<u>Serial Number:</u>	<u>Instrument Range:</u>
N1 <b>Force Transducer</b>	<b>LC7</b>	<b>7</b>	$\pm$ <b>30</b> kip
<u>Calibration Trace:</u>	<u>Certificate Number:</u>	<u>Cal. Date:</u>	<u>Cal. Exp. Date:</u>
	<b>ub-2004-06-20-06</b>	<b>06/20/2004</b>	<b>06/20/2005</b>
2. <u>Type of Instrument:</u>	<u>Instrument Name:</u>	<u>Serial Number:</u>	<u>Instrument Range:</u>
N2 <b>Force Transducer</b>	<b>LC9</b>	<b>9</b>	$\pm$ <b>30</b> kip
<u>Calibration Trace:</u>	<u>Certificate Number:</u>	<u>Cal. Date:</u>	<u>Cal. Exp. Date:</u>
	<b>ub-2004-06-20-08</b>	<b>06/20/2004</b>	<b>06/20/2005</b>
3. <u>Type of Instrument:</u>	<u>Instrument Name:</u>	<u>Serial Number:</u>	<u>Instrument Range:</u>
Ref <b>Force Transducer</b>	<b>UB#300kip</b>	<b>LC300-01</b>	<b>300 kip (compression)</b>
<u>Calibration Trace:</u>	<u>Certificate Number:</u>	<u>Cal. Date:</u>	<u>Cal. Exp. Date:</u>
<b>NIST Traceable</b>	<b>NMC - 1044276</b>	<b>11/21/2003</b>	11/20/2004
<b>NEM-8115: 300k Load Cell</b>			
<b>822/2650366-01</b>			

Calibration Factors:

<u>Full Scale Output:</u>	<u>Unamplified Full Scale Output</u>	<u>Amplified Output per Eng. Unit:</u>
1. <b>30 Kip</b>	<b>20mV</b>	$\pm$ <b>0.1460</b> mV/kip
2. <b>30 Kip</b>	<b>20mV</b>	$\pm$ <b>-0.1412</b> mV/kip
3. <b>300 Kip</b>	<b>20mV</b>	<b>33.300</b> mV/kip

Reference Lab Information:

1. <u>Address:</u>	<u>Phone/Website:</u>	<u>Accreditation:</u>
<b>Ketter Hall SEESL</b>	<b>645-2114</b>	
<b>University at Buffalo</b>	<a href="http://www.nees.buffalo.edu">www.nees.buffalo.edu</a>	
<b>Buffalo, NY 14225</b>		
2. <u>Address:</u>	<u>Phone/Website:</u>	<u>Accreditation:</u>
<b>Ketter Hall SEESL</b>	<b>645-2114</b>	
<b>University at Buffalo</b>	<a href="http://www.nees.buffalo.edu">www.nees.buffalo.edu</a>	
<b>Buffalo, NY 14225</b>		
3. <u>Address:</u>	<u>Phone/Website:</u>	<u>Accreditation:</u>
<b>Northeast Metrology Corp.</b>	<b>716-827-3770</b>	<b>ISO/IEC 17025</b>
<b>2601 Genesee Street</b>	<a href="http://www.vantek-nem.com">www.vantek-nem.com</a>	
<b>Buffalo, NY 14225-2916</b>		

**Department of Civil, Structural, and Environmental Engineering**

**SEESL Structural Engineering and Earthquake Simulation Laboratory SEESL**

212 Ketter Hall, North Campus, Buffalo, NY 14260-4300

Fax: (716) 645-3733 Tel: (716) 645 5400 X 16

<http://www.sees.buffalo.edu>

Calibration Information

**Calibration Procedure:**

Basic Description:

*AXIAL CALIBRATION:*

The three load cells (LC7, LC9, and LC5) were placed on top of the UB#300kip reference load cell in the Tinius Olsen machine. The load cells were loaded several cycles to allow the gains of the amplifiers to be adjusted to match the calibrated reference. LC7 and LC9 were calibrated to be used as normal force references 1 and 2 respectively.

*SHEAR CALIBRATION:*

The load cells were set up as shown in Figure 1, then loaded. The gain of the shear conditioner was adjusted such that the shear reaction matched that of LC9.

*MOMENT CALIBRATION:*

The load cells were set up as shown in Figure 2, then loaded. The gain of the moment conditioner was adjusted such that the moment reading matched that of LC9 times the distance from the loading point to moment strain gages.

Distance from moment gages to: **top = 3.500 in** bottom = **2.750 in**

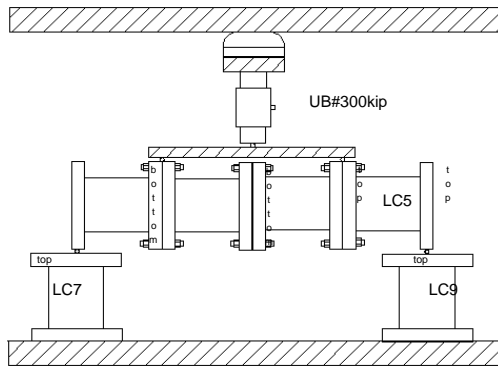

Figure 1: Shear Configuration

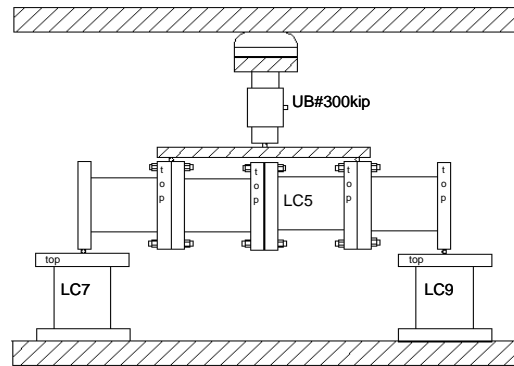

Figure 2: Moment Configuration

Standard:



## Department of Civil, Structural, and Environmental Engineering

### SEESL Structural Engineering and Earthquake Simulation Laboratory SEESL

212 Ketter Hall, North Campus, Buffalo, NY 14260-4300

Fax: (716) 645-3733 Tel: (716) 645 5400 X 16

<http://www.nees.buffalo.edu>

#### Calibration Data:

Certificate Number: UB-2004-06-20-04

[Normal Calibration Data](#)

Graph:

#### Normal Calibration

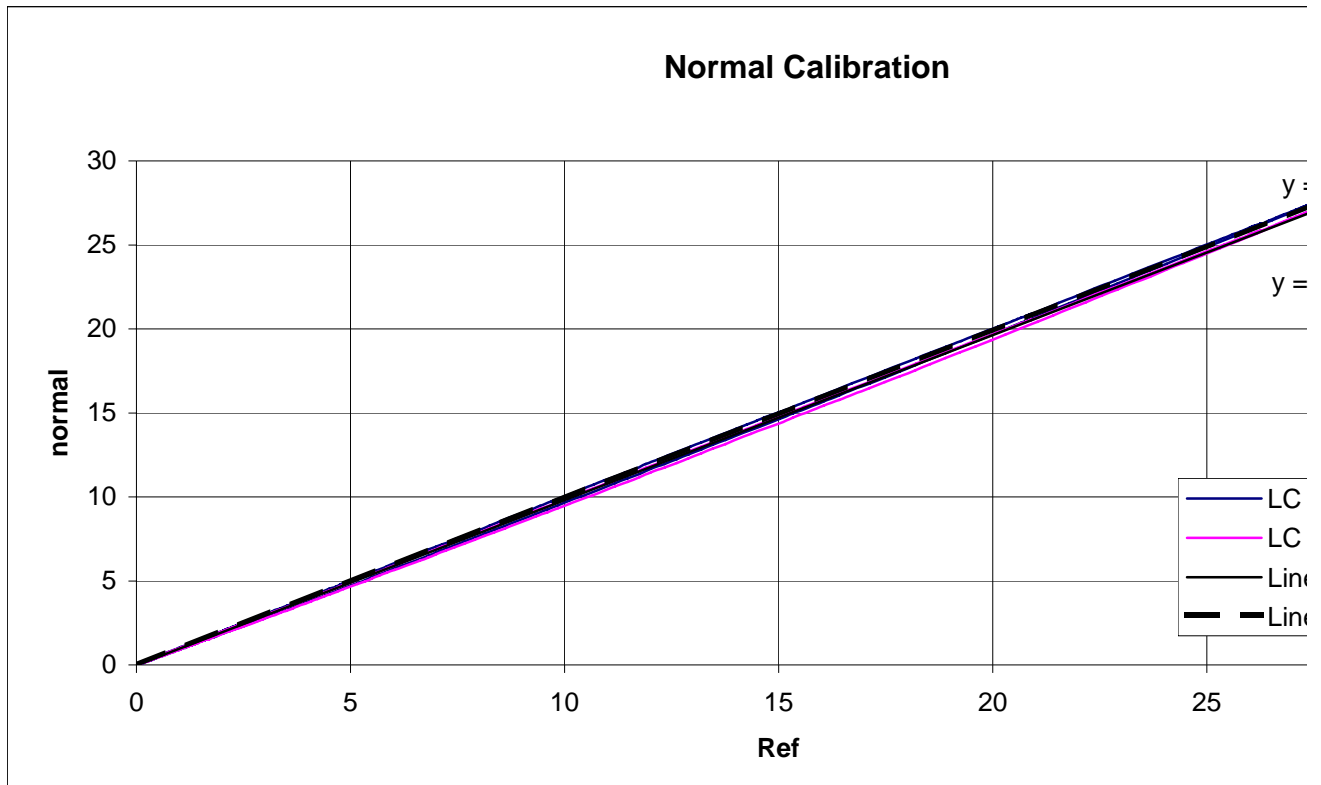



Department of Civil, Structural, and Environmental Engineering

SEESL Structural Engineering and Earthquake Simulation Laboratory SEESL

212 Ketter Hall, North Campus, Buffalo, NY 14260-4300

Fax: (716) 645-3733 Tel: (716) 645 5400 X 16

<http://www.nees.buffalo.edu>

[Shear Calibration Data](#)

Graph:

Shear Calibration LC5 ( $\pm 0.476$  mV/kip)

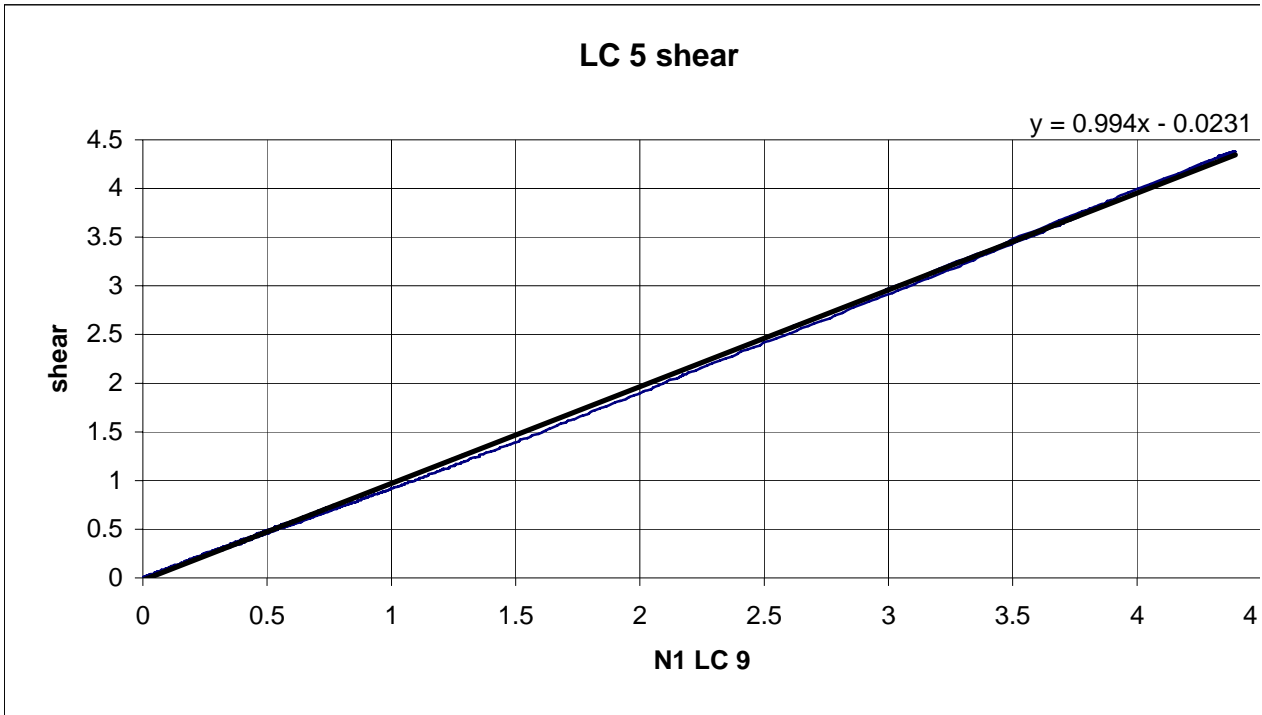



Department of Civil, Structural, and Environmental Engineering

SEESL Structural Engineering and Earthquake Simulation Laboratory SEESL

212 Ketter Hall, North Campus, Buffalo, NY 14260-4300

Fax: (716) 645-3733 Tel: (716) 645 5400 X 16

<http://www.nees.buffalo.edu>

Moment Calibration Data

Graph:

Moment Calibration LC5 ( $\pm 0.174$  mV/kip-in)

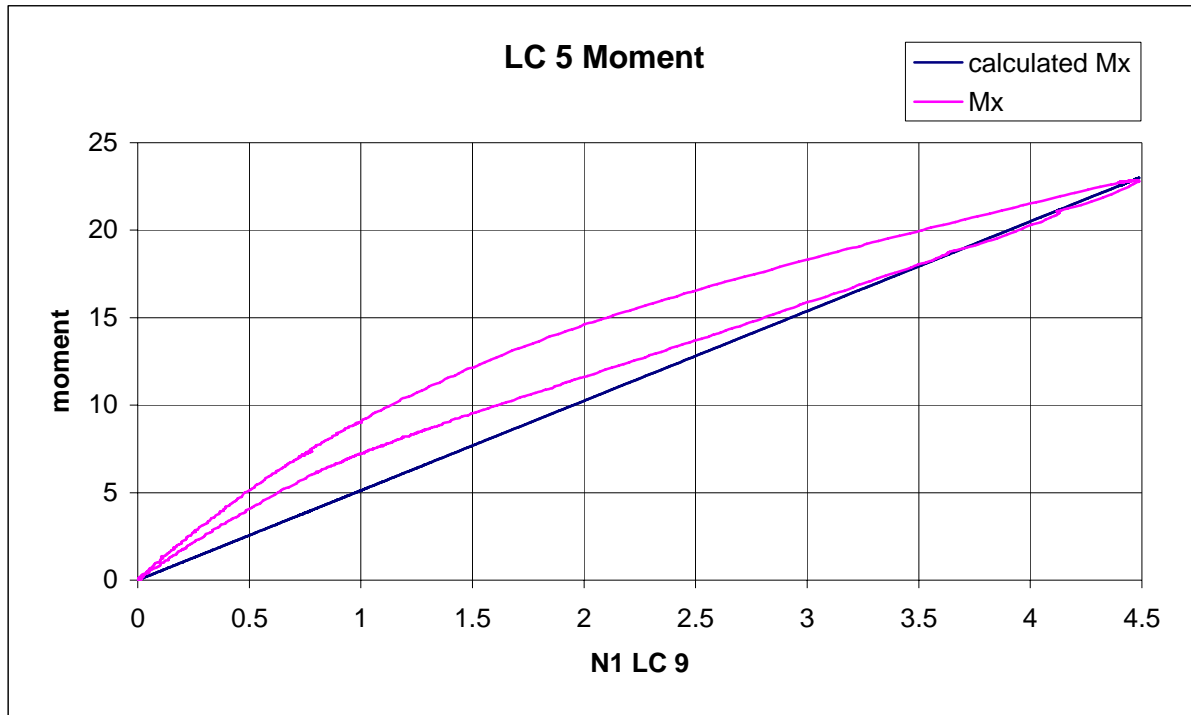

Calibration Factors:

Ax  $\pm 0.147$  mV/kip  
Sx  $\pm -0.476$  mV/kip  
Mx  $\pm -0.174$  mV/kip-in

Comments:

**Personnel Identification:**

Name:

Scot Weinreber

Company:

UB

Signature:

Date:

6/20/2004

**Calibration Period:**

Cal. Date:

6/20/2004

Cal. Exp. Date:

6/20/2005

Structural Engineering



Earthquake Simulation

Laboratory



**Department of Civil, Structural, and Environmental Engineering**

---

---

**SEESL** *Structural Engineering and Earthquake Simulation Laboratory* **SEESL**

212 Ketter Hall, North Campus, Buffalo, NY 14260-4300

Fax: (716) 645-3733 Tel: (716) 645 5400 X 16

<http://www.nees.buffalo.edu>





**Department of Civil, Structural, and Environmental Engineering**

**SEESL** *Structural Engineering and Earthquake Simulation Laboratory* **SEESL**

212 Ketter Hall, North Campus, Buffalo, NY 14260-4300

Fax: (716) 645-3733 Tel: (716) 645 5400 X 16

<http://www.nees.buffalo.edu>







**Department of Civil, Structural, and Environmental Engineering**

**SEESL** *Structural Engineering and Earthquake Simulation Laboratory* **SEESL**

212 Ketter Hall, North Campus, Buffalo, NY 14260-4300

Fax: (716) 645-3733 Tel: (716) 645 5400 X 16

<http://www.nees.buffalo.edu>



ding

t

*Structural Engineering*



*Earthquake Simulation*

*Laboratory*



**Department of Civil, Structural, and Environmental Engineering**

**SEESL** Structural Engineering and Earthquake Simulation Laboratory **SEESL**

212 Ketter Hall, North Campus, Buffalo, NY 14260-4300

Fax: (716) 645-3733 Tel: (716) 645 5400 X 16

<http://www.sees.buffalo.edu>

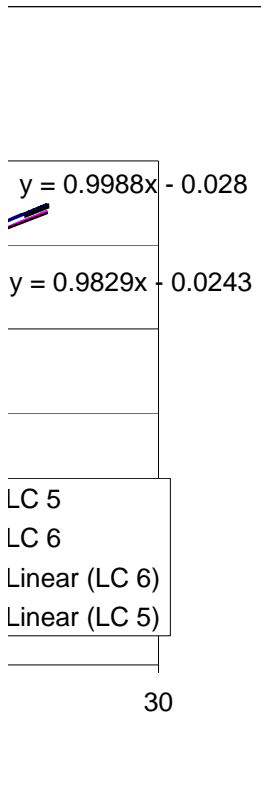



**Department of Civil, Structural, and Environmental Engineering**

**SEESL** *Structural Engineering and Earthquake Simulation Laboratory* **SEESL**

212 Ketter Hall, North Campus, Buffalo, NY 14260-4300

Fax: (716) 645-3733 Tel: (716) 645 5400 X 16

<http://www.nees.buffalo.edu>

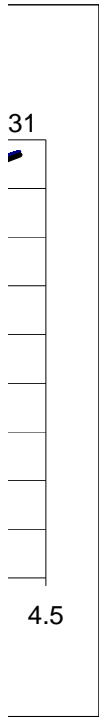



**Department of Civil, Structural, and Environmental Engineering**

---

---

**SEESL** *Structural Engineering and Earthquake Simulation Laboratory* **SEESL**

212 Ketter Hall, North Campus, Buffalo, NY 14260-4300

Fax: (716) 645-3733 Tel: (716) 645 5400 X 16

<http://www.nees.buffalo.edu>